

# MITUM

[www.mitum.com.pl](http://www.mitum.com.pl), [mitum@mitum.com.pl](mailto:mitum@mitum.com.pl)  
tel. 661 241 966



ZIG-ZAG





# ZIG-ZAG SYSTEM



**PLATFORM**  
4-11



**MANAGER**  
12-19



**SINGLE & DOUBLE**  
20-23

## SPACE FOR INTERACT

Zig-Zag is a **perfect solution** for companies in which the basic role fulfill teams consisting of a few persons who need space to interact freely. Desk tops enlarged by add-on devices provide more space and allow a few people to join the

team without any problems and continue collective work. **Module character** of the system and reduced pattern-designing are in accordance with the technical and esthetic needs of contemporary office.







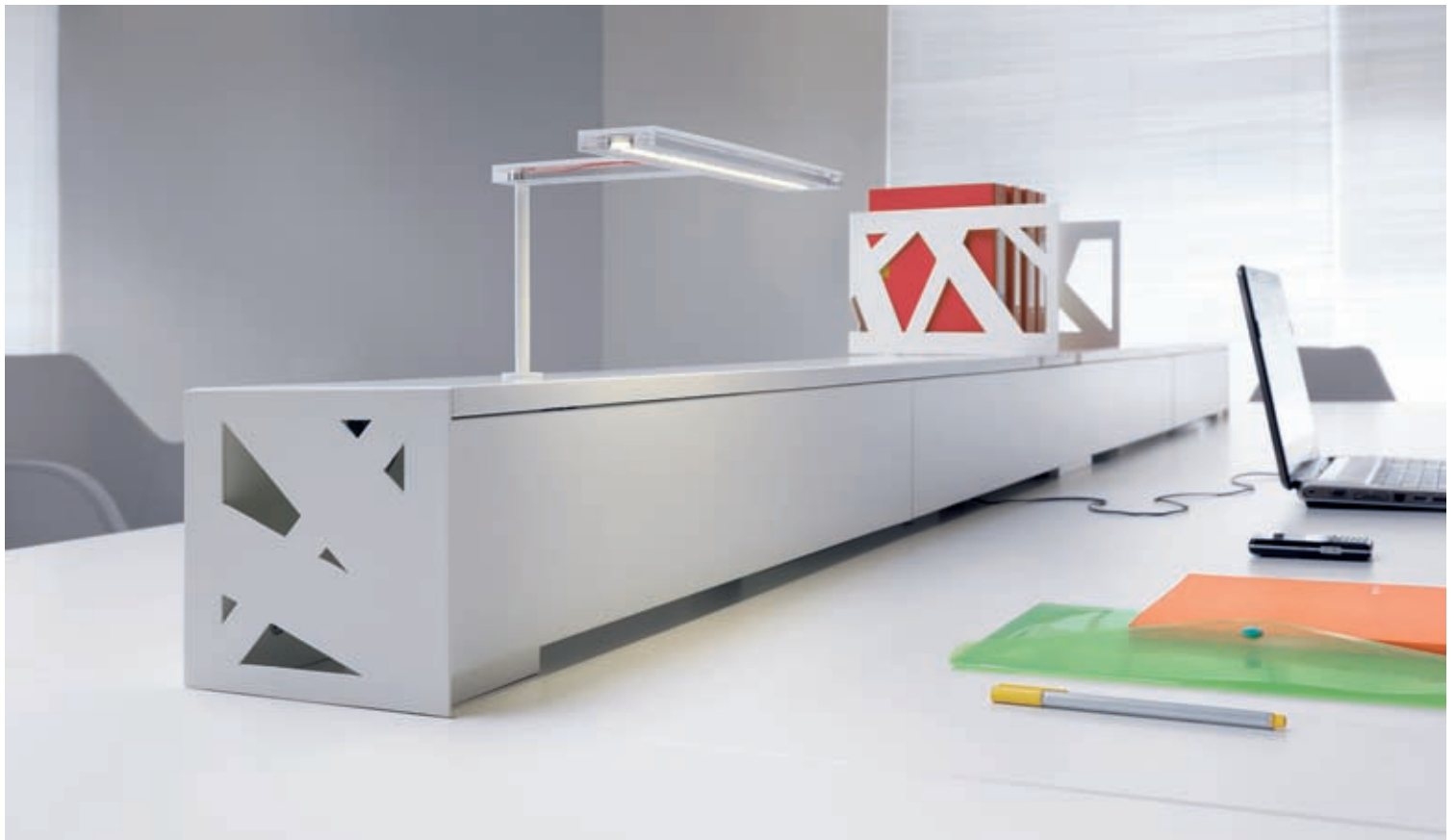

The area for **team work** is often connected with the mobility of the workers. In this case the crucial element shall provide **fast and easy access** to sockets for the workers as well as free communication among the members of the team. Upholstered panels hide media-ports offering

place for accessories and trinkets. On the cover of the panels there are openwork containers for documents and additional sources of light. Due to the abovementioned the workstand becomes **more practical**, comfortable and ergonomic.





All elements which constitute the system are a collection of **basic geometric shapes** of a rectangle and a square. Independent and integrated workstations are connected with the simple shape of a desk top, differentiated only by

the width of the working area. The construction of the desk provides **perfect ergonomics** – a wide area for work, a place for a keyboard and documents, a screen, a telephone and all things which are **essential** for a **modern workstation**.





Zig-Zag **platforms** were designed in such a way to provide quick access and do not cause any problems. That is why they can be exchanged and divide the workstands with a straight or

cross-shaped line. The panels are decorated with ornamented openwork covers made of white metal which fastens the partition and provides a **unique character** of the desk.





White metal **openwork** is a characteristic element of the Zig-Zag system. It is designed in a form of zigzags crossing on the frontal parts of the cupboards, embracing the panels

or decorating the additional accessories. Apart from that, the **mobile container** with a system of quietly closing drawers and a pen box allows to keep stationery in order.





Zig-Zag cupboard connects esthetics and **elegance** with **ergonomics**. Impressive frontal parts with a zigzag pattern cover perfectly designed interior with huge drawers and shelves for files. The system provides a possi-

bility to chose the frontal part of the cupboard due to the arrangement – despite the most characteristic openwork the frontal parts made of melamine of **elegant shining** HPL material are also available.





## SPACE FOR IMPRESS

Is a simple, **multifunctional** and comfortable system which matches various offices. Starting from the reception desk through the open staff

rooms to the managers' offices – Zig-Zag creates a **modern office** and provides its unique character.





An opportunity to **concentrate** and have a feeling of **discretion** with being open to the contact with the subordinates is the most crucial element in each office. The workstand for a **manager** in the Zig-Zag system perfectly

fulfills these functions and allows to organize work perfectly. Due to handy additional accessories integrated with the desk the most important elements are always accessible.





## SPACE TO CREATE

Zig-Zag perfectly functions in a separate area. It is also an optimal place for a small team. **Integrated workstands** lean against the side extensions and allow to organize work in small rooms with a free exchange of ideas to

solve problems. The main part of the extension can be used also as an additional place for documents or office equipment. The desks are equipped with media-ports providing comfort and access to electricity.



19 20 21 22 23 24 25  
26 27 28 29 30 01 02  
03 04 05 06 07 08 09  
10 11 12 13 14 15 16  
17 18 19 20 21 22 23  
24 25 26 27 28 29 30  
31 01 02 03 04 05 06  
07 08 09 10 11 12 13

SYCZEN



The partition walls are very useful in a situation when the performed tasks required concentration and silence. Zig-Zag allows to create **independent boxes** consisting of one or a few workstands, separated with additional panels.

The construction of the partition wall allows to assembly various kinds of shelves and additional accessories over the desk. Next to the desk top there is a shuttered cupboard which can be used as a container.



In case of workstations which are located in independent Bowers the most crucial thing is a possibility to use the sockets and the Internet without any problems. Zig-Zag desks are equipped with comfortable and **accessible media-ports** allowing for a quick connection of the office

equipment with the Internet. Esthetic appearance of the workstand is provided by the canals in the partition walls which hide the cables of the electric and communication network. Due to half-open slats additional devices can be connected without any problems and with-

out the need to disassemble the construction. Additional elements such as hanging shelves or shuttered cupboards complete the system in terms of **functionality** and provide a satisfactory amount of space for documents and files.



DESKS

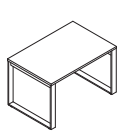

**ZBI 02**  
1200/800/740

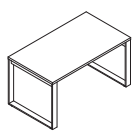

**ZBI 04**  
1400/800/740

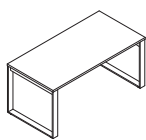

**ZBI 06**  
1600/800/740

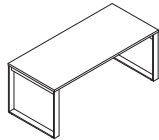

**ZBI 08**  
1800/800/740

EXTENSION



**ZPI 016**  
1618/600/740



**ZPI 08**  
800/600/740

MODESTY PANELS



**UH 2**  
1000/18/400



**UH 3**  
1200/18/400



**UH 4**  
1400/18/400

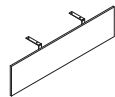

**UH 5**  
1600/18/400

PARTITION WALLS

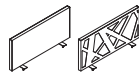

**ZP 001**  
800/36/360

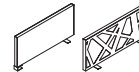

**ZP 02**  
800/36/360

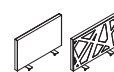

**ZP 004**  
600/36/360

SCREENS



**ZP 012**  
1200/18/350



**ZP 014**  
1400/18/350

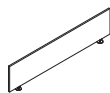

**ZP 016**  
1600/18/350



**ZP 018**  
1800/18/350

PARTITION WALLS WITH PINBOARDS



**ZP 012P**  
1200/46/350



**ZP 014P**  
1400/46/350



**ZP 016P**  
1600/46/350



**ZP 018P**  
1800/46/350

ACOUSTIC PANELS



**RA 12**  
1200/29/353



**RA 14**  
1400/29/353

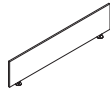

**RA 16**  
1600/29/353



**RA 18**  
1800/29/353

CABINETS

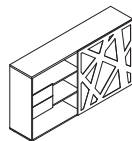

**ZS 01**  
2000/434/1129

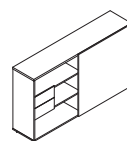

**ZS 02**  
2000/434/1129  
HPL front

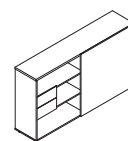

**ZS 03**  
2000/434/1129  
melamine front

MOBILE PEDESTALS



**SLD 12**  
416/600/590  
**SLD 12HT\***  
416/600/590



**SLD 13**  
416/600/590  
**SLD 13HT\***  
416/600/590



**ZP 03**  
400/300/200

SHELF

CONFERENCE TABLE

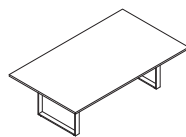

**ZBK 01**  
2400/1400/740

COFFEE TABLE

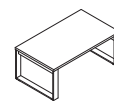

**ZBS 10**  
1200/700/550

\*HT top and front with HPL

melamine boards:

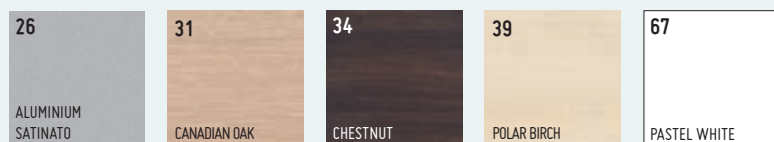

HPL:

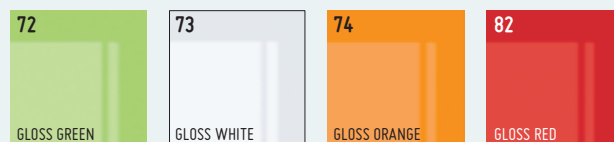

DESKS WITH CABINET

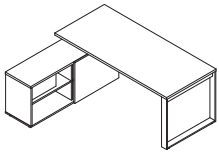

**ZBL 10**  
1800/1902/1600/740

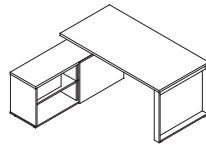

**ZBL 11**  
1600/1702/1600/740

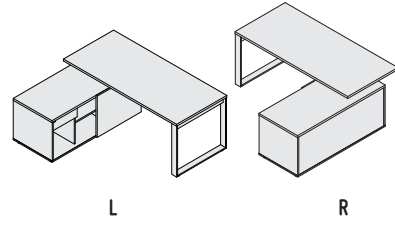

**L**                      **R**

DESKS WITH CABINET

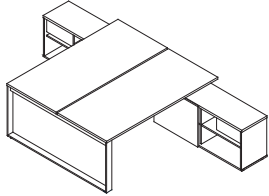

**ZBL 020** 1800/1902/3218/740

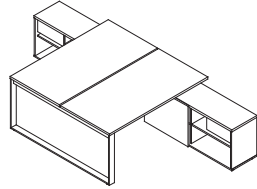

**ZBL 021** 1600/1702/3218/740

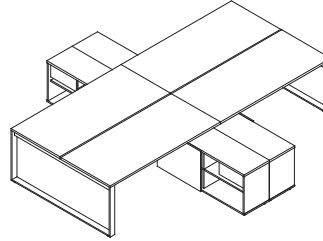

**ZBL 040** 3600/3804/3218/740

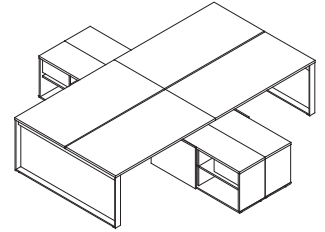

**ZBL 041** 3200/3404/3218/740

BENCHES

example set:

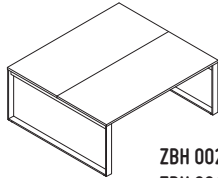

**ZBH 002** 1200/1618/740  
**ZBH 004** 1400/1618/740  
**ZBH 006** 1600/1618/740  
**ZBH 008** 1800/1618/740

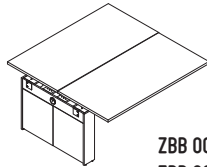

**ZBB 002** 1200/1618/740  
**ZBB 004** 1400/1618/740  
**ZBB 006** 1600/1618/740  
**ZBB 008** 1800/1618/740

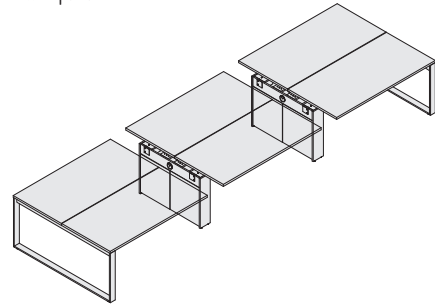

PLATFORM

example set:

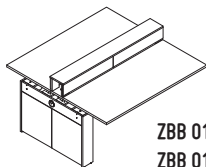

**ZBB 014** 1400/1618/740  
**ZBB 016** 1600/1618/740

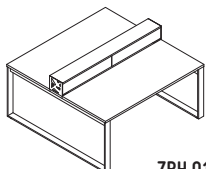
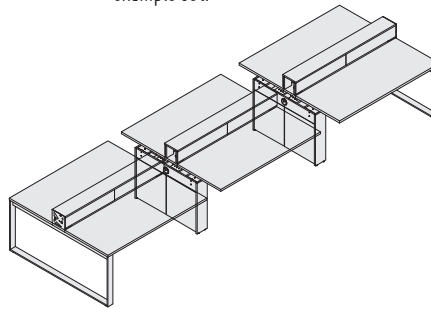

**ZBH 014** 1400/1618/740  
**ZBH 016** 1600/1618/740

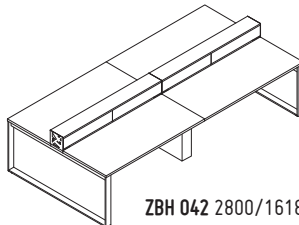

**ZBH 042** 2800/1618/740  
**ZBH 044** 3000/1618/740  
**ZBH 046** 3200/1618/740

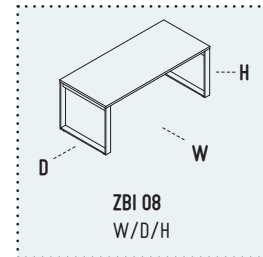

**ZBI 08**  
W/D/H



The partner (co-organiser) is IKER a producer of modern upholstery furniture, chairs and lighting. The followings pieces of furniture were used: Lemming, Plumm and Magnetic. We welcome everyone to see the full range of our collection at [www.iker.com.pl](http://www.iker.com.pl)

support frames:

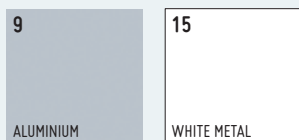

fabrics:



# MITUM

[www.mitum.com.pl](http://www.mitum.com.pl), [mitum@mitum.com.pl](mailto:mitum@mitum.com.pl)  
tel. 661 241 966

 **mdd**  
OFFICE FURNITURE FACTORY

[www.mdd.eu](http://www.mdd.eu)    [info@mdd.eu](mailto:info@mdd.eu)

